

HZCDP-30kV

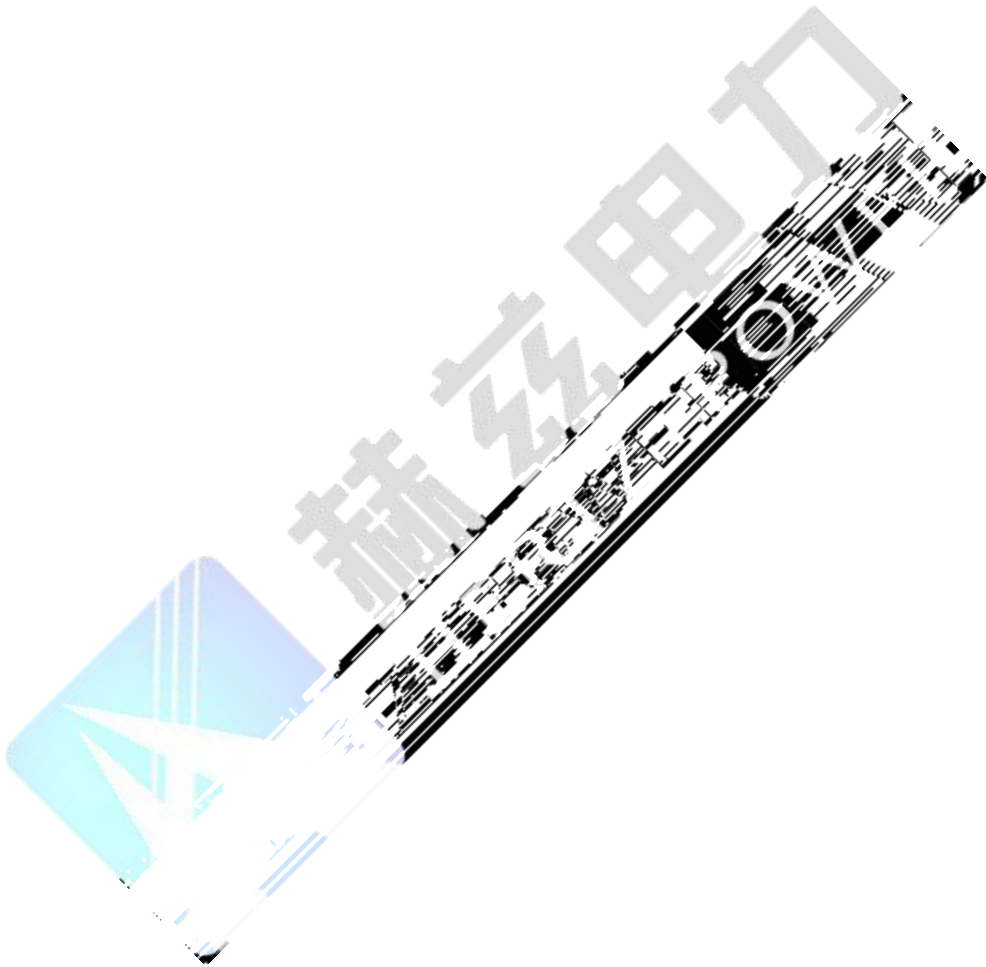

--	--	--	--	--	--	--

1 0.1Hz

2

1.2

1	DL/T 849.4-2004	4
2	Q/ED116501-2004	

1.3

1.

9.

10.

1. 4

1. 220V± 5% 50± 2Hz

3kW

50Hz 220V± 5%

2. 30kV

3. 0. 1Hz 0. 05Hz 0. 02Hz

4. 0. 1Hz- 1. 1uF 0. 05Hz- 2. 2uF 0. 02Hz- 5. 5uF

4. 3%

5. 3

6. 5

7. -10 +40 85 RH

1. 5

1.

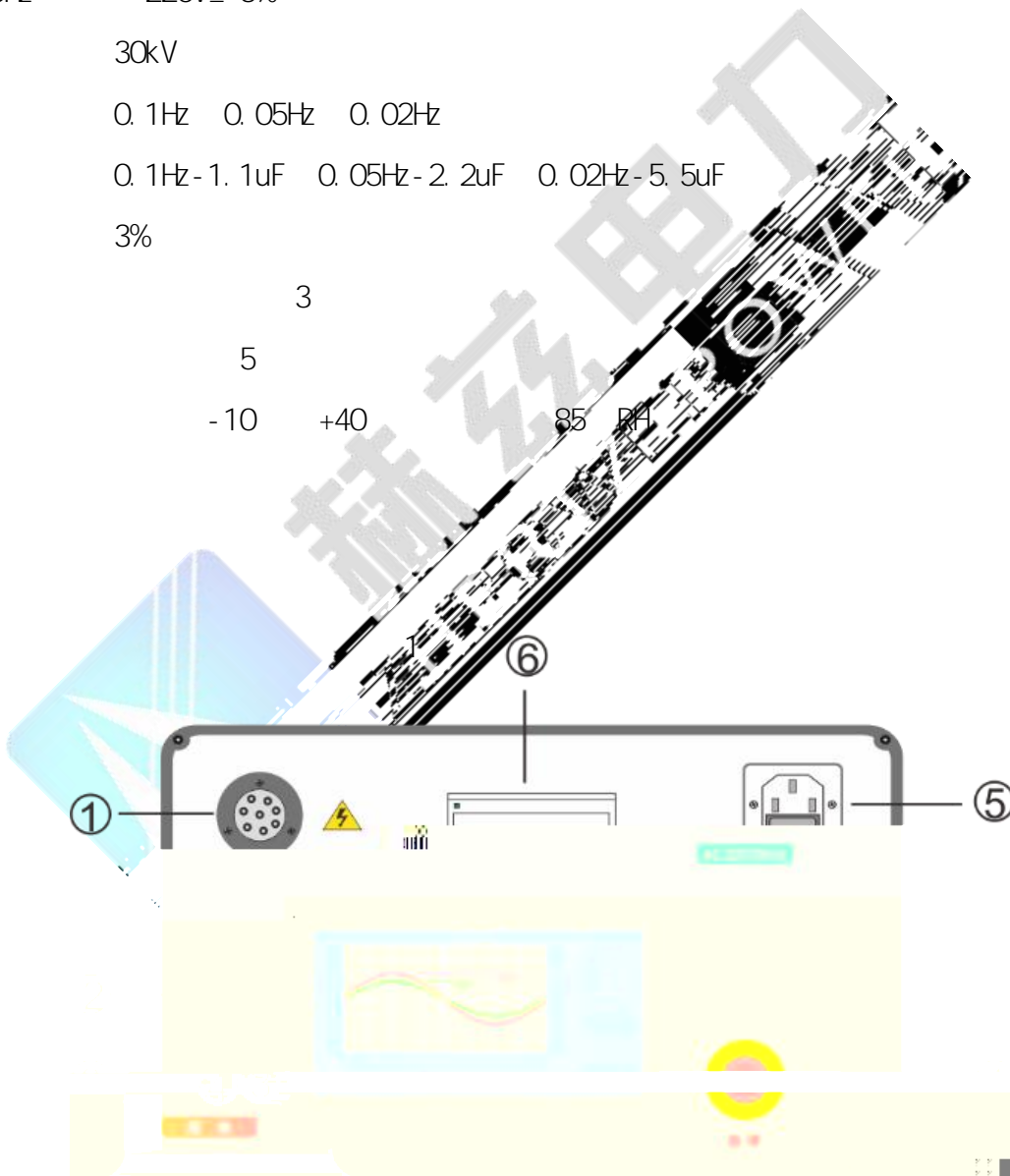

|

1

1 .

2 .

3 .

4 . /

5 . AC220V

6 .

2.

2

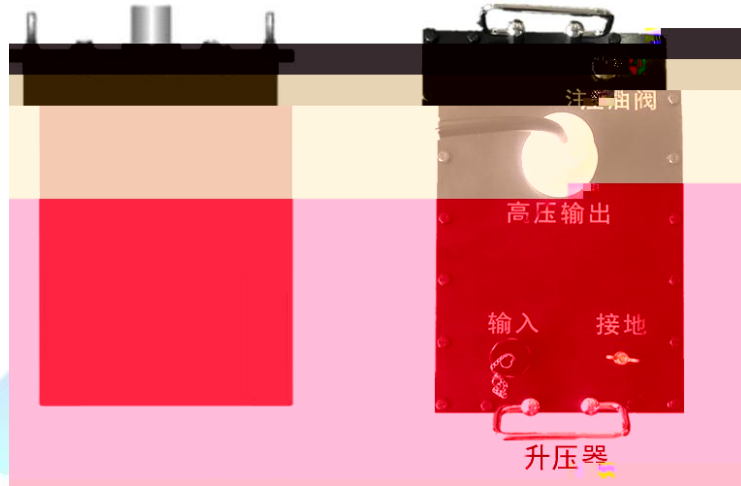

2

1 1.

2

3

4

2.1

AC220V

3

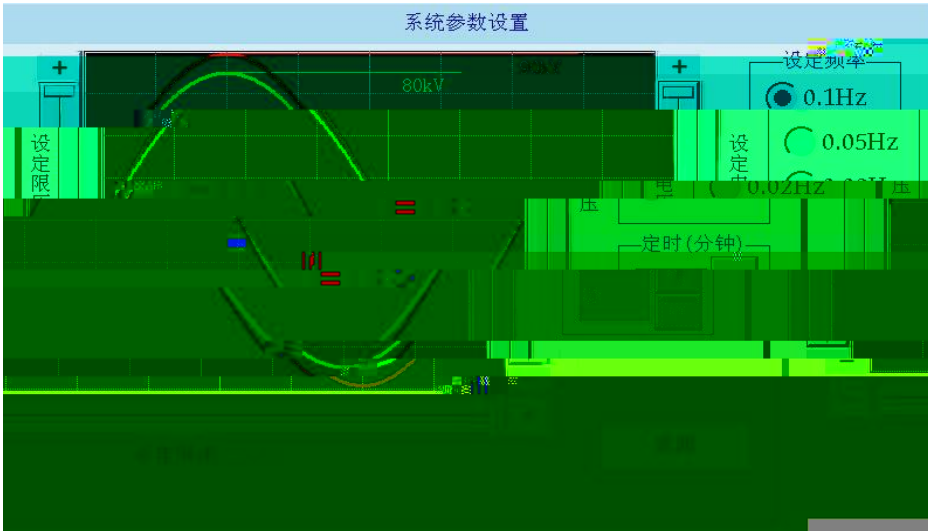

1. " " " + " " - "
 2. / 1kV " " + " " - "
 3. / 1kV " " " + " " - "
 4. / 1mA " " " + " " - "
3. 3 0.1Hz 0.05Hz 0.02Hz
4. 99 " + " - "
- " "

2.2

" "

4

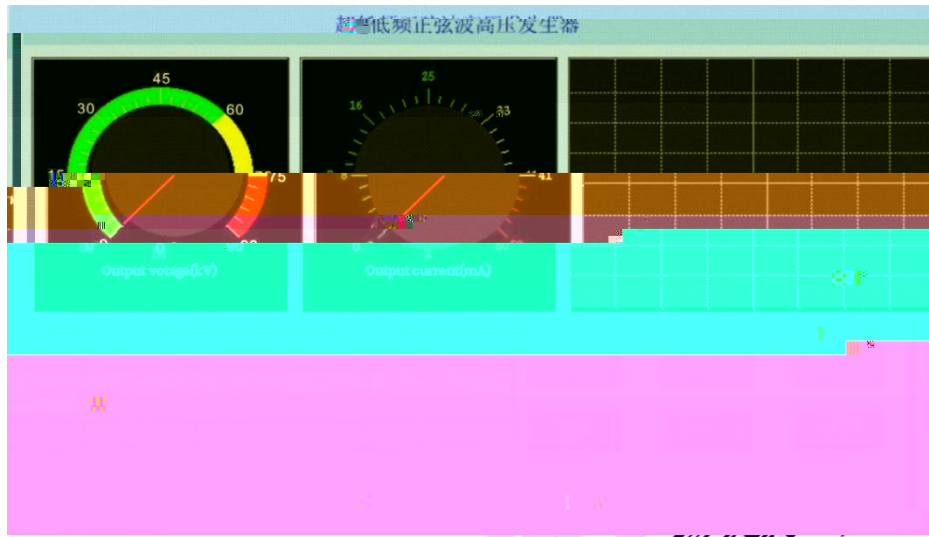

4

2.3

" "

5

" "

64

64

电压 (kV)	电流 (mA)	频率 (Hz)	时长	时间
25	12	0.1	00:20:53	2010/02/19 14:23:48

Buttons: 打印 (Print), 返回 (Return)

5

3.2

3.2.1

" "

" "

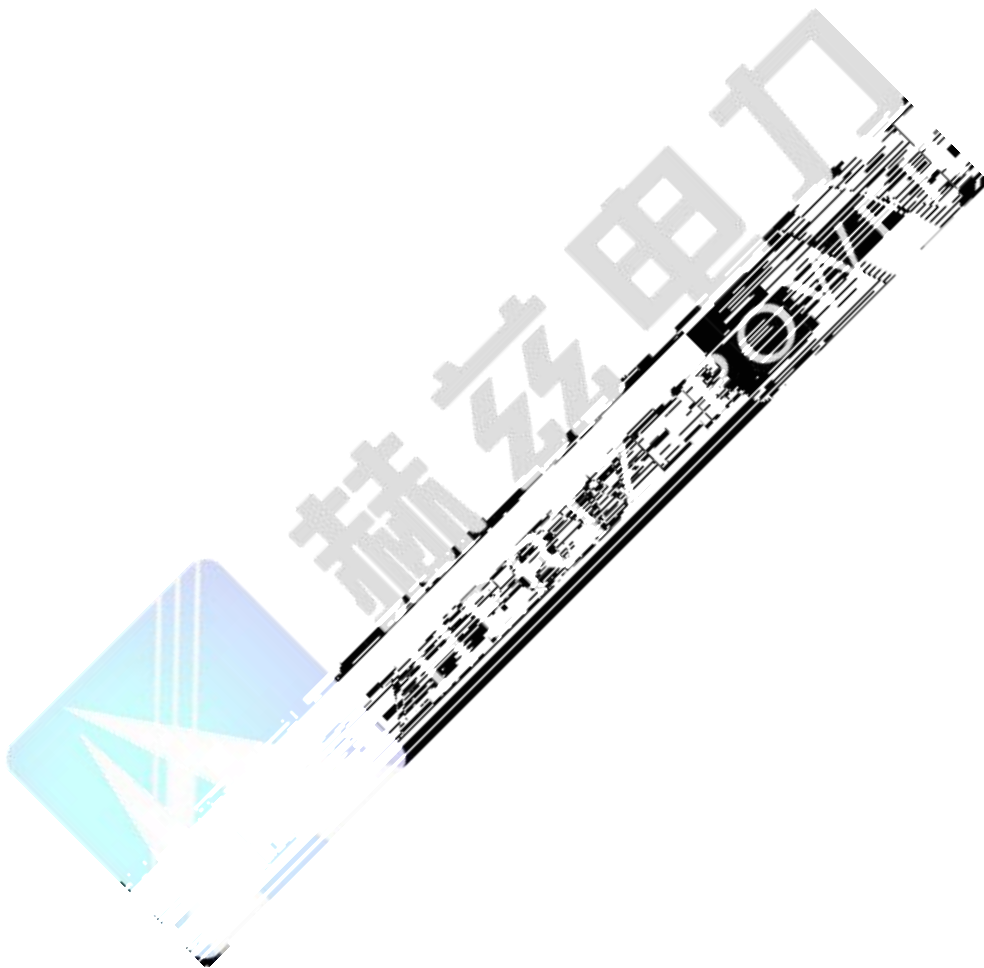

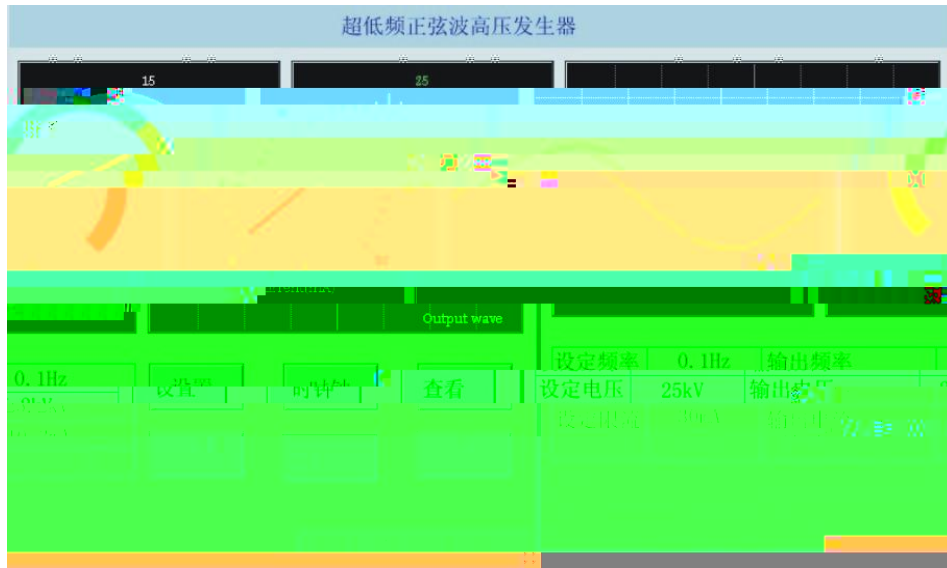

10

3.2.4

"

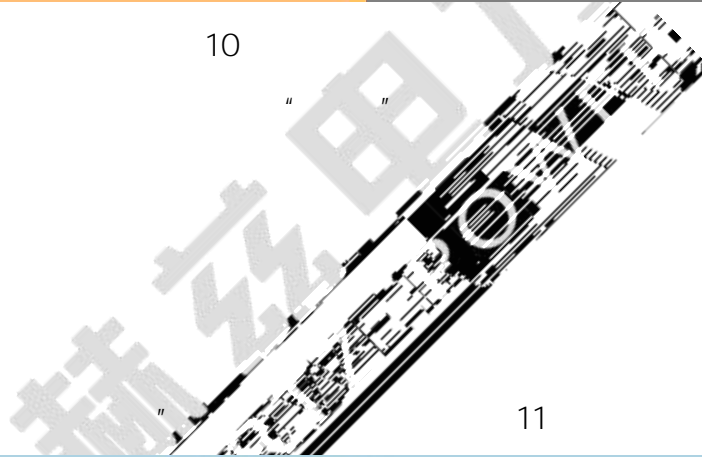

11

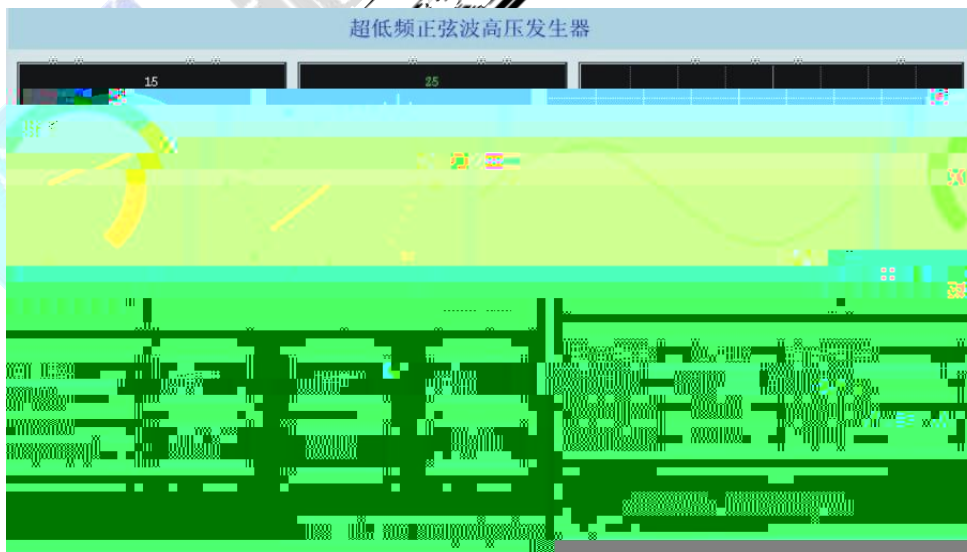

11

3.2.4

12 13

225

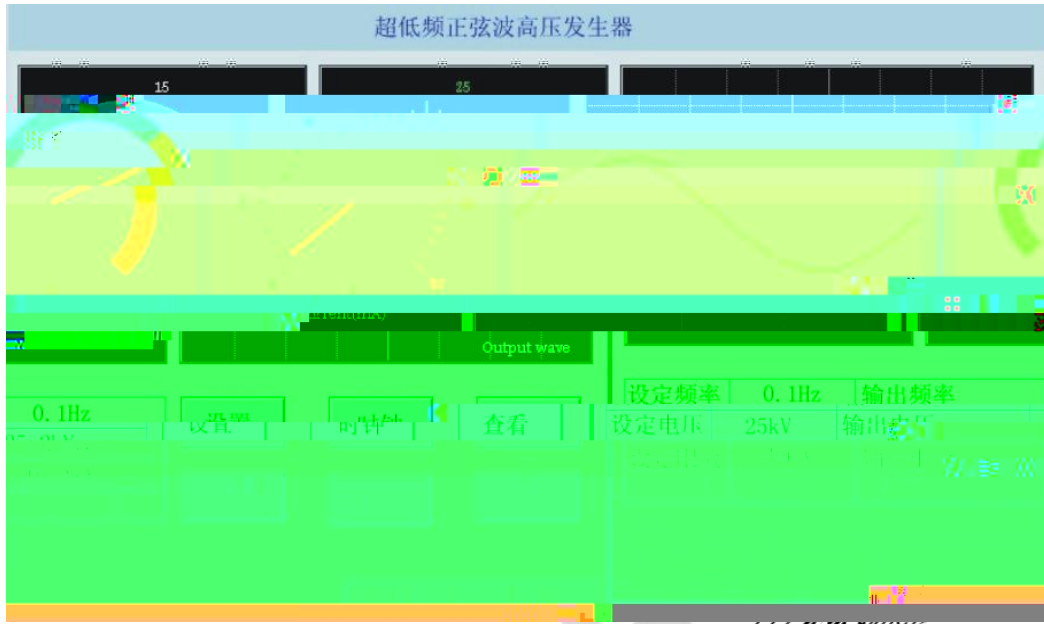

12



13

4.1

1.

2.

3.

1

$U_{max}=3U_0$

U_0

10kV

$U_0=6kV$

$U_{max}=3U_0=18kV$

0.1Hz

3

额定电压		交接试验			预防性试验		
$3U_0$	5	60	$3U_0$	5	15	1.8/3	
$3U_0$	11	60	$3U_0$	11	15	3.6/6	
$3U_0$	18	60	$3U_0$	18	15	6/6	
$3U_0$	18	60	$3U_0$	18	15	6/10	
$3U_0$	26	60	$3U_0$	26	15	8.7/10	
$3U_0$	36	60	$3U_0$	36	15	12/20	

UN

3

0.1Hz

U_0

0.05μ F

4.

60

15

5.

6.

$I_0=2 fCU=2 \times 3.14 \times 0.1CU(mA) \dots\dots\dots (1)$

C

μF U

kV

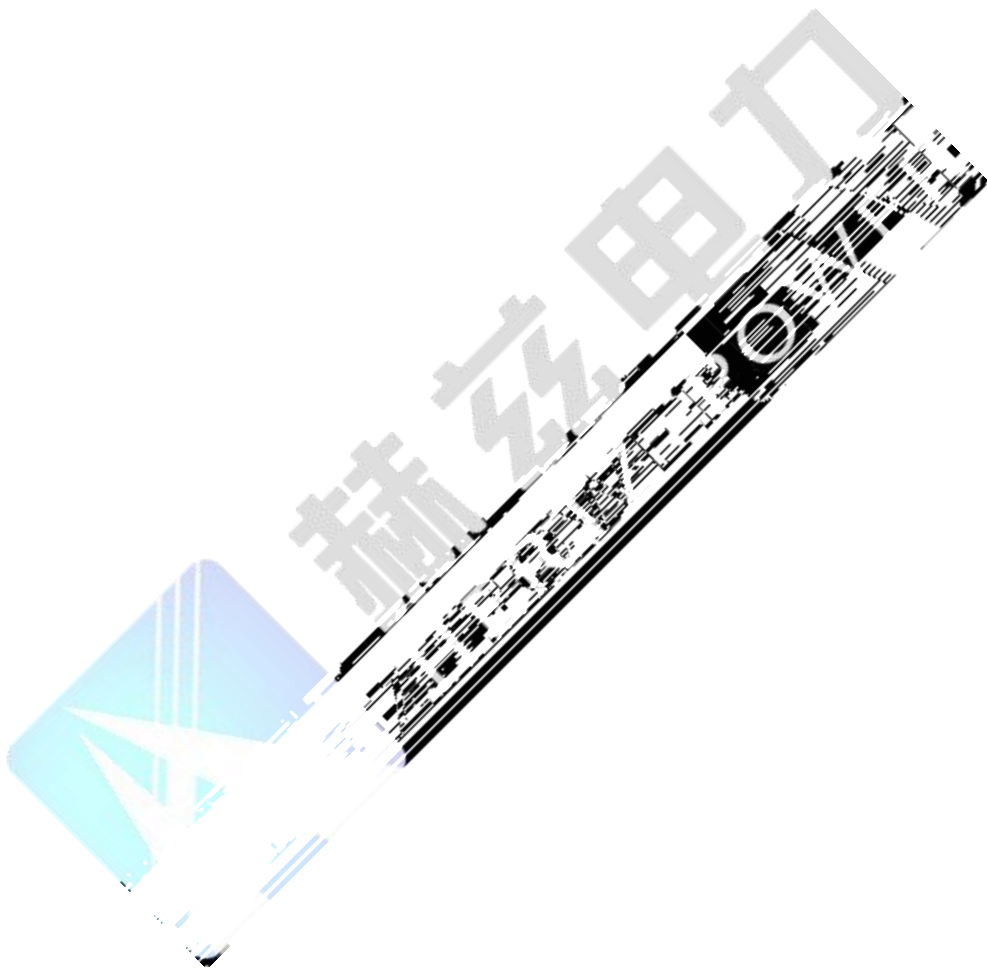



10.

4.2

1

0.1Hz

2

15

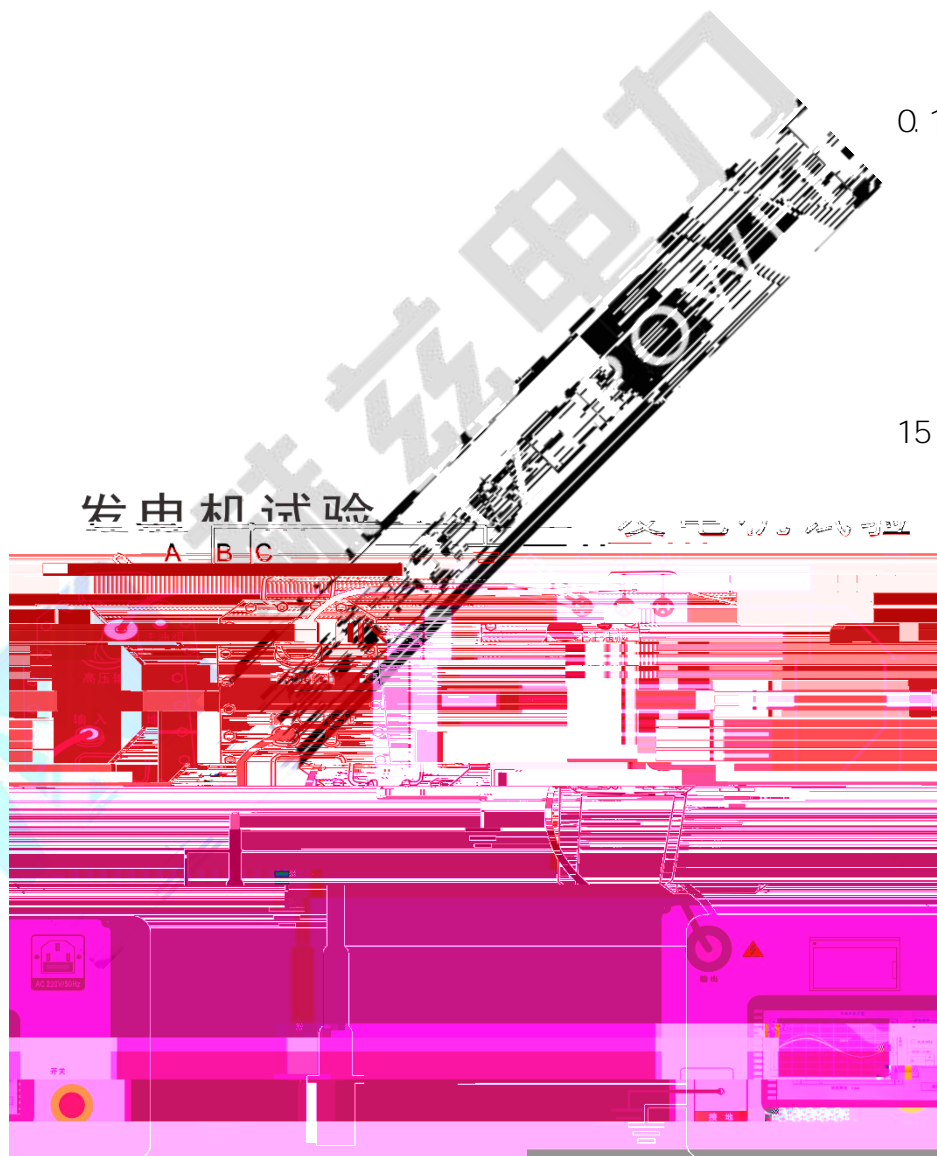

15

3

max 2 U₀

max 0.1Hz kV

0.1Hz 50Hz , 1.2

1.3 1.5 1.5

0 kV

13.8 kV

max \sqrt{x}

1.2× 1.5× 13.8 35.1(kV)

4

5

	汽轮发电机			水轮发电机			
发电机容量 (MW)	300	300	600	85	100-150	300	400
单相对地电容 (pF)	0.198	0.18~0.26	0.31~0.34	0.22	1.5~1.5	1.5~1.5	2.0~2.5



11-12

16

4.4

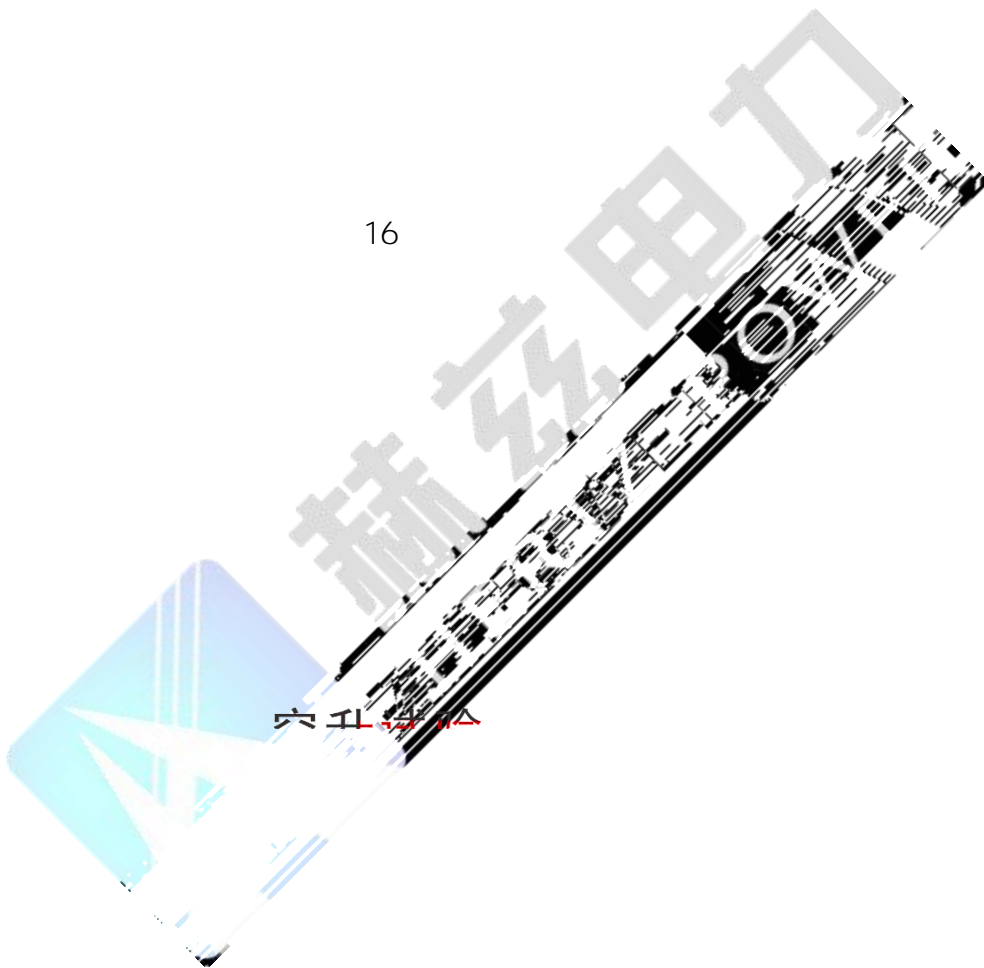

17

17

225



- 1.
- 2.
- 3.

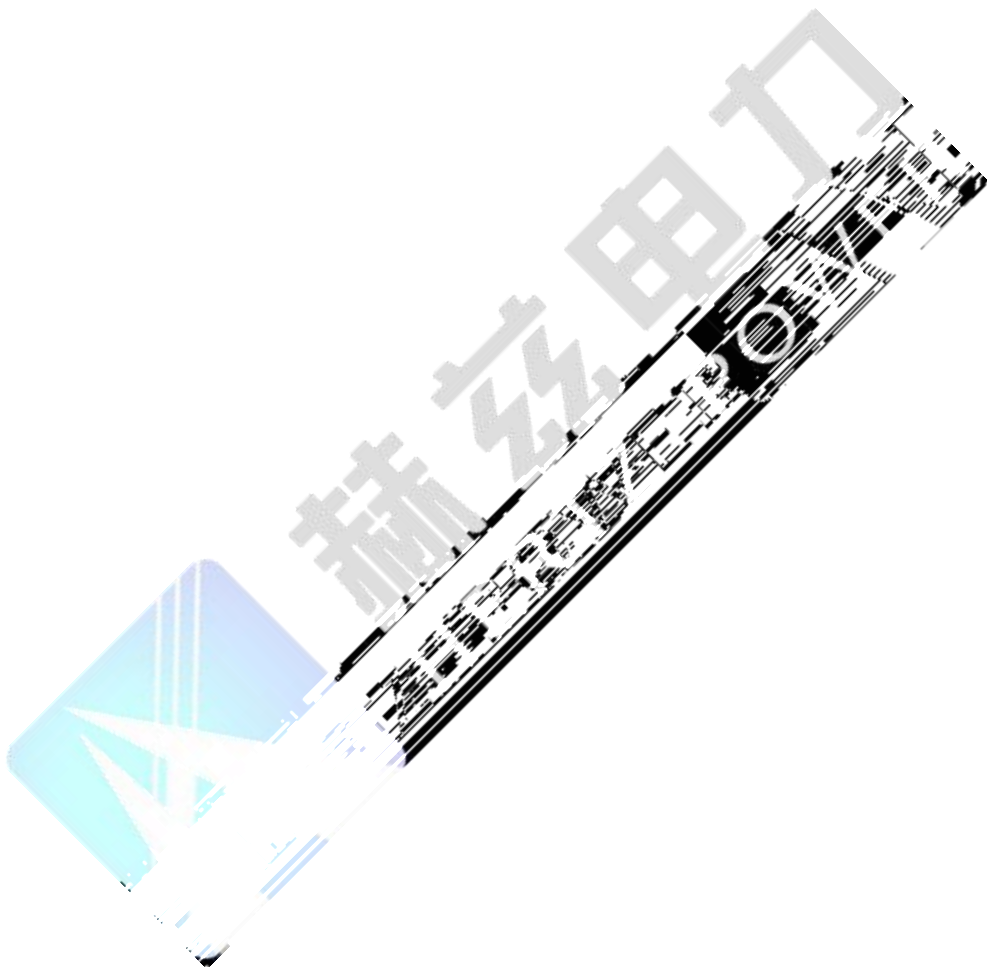



1		1	
2		1	
3		2	
4		1	
5		1	
6			
7			
8		1	
9		3	
10		2	
11		1	
12		1	
13		1	

c " e

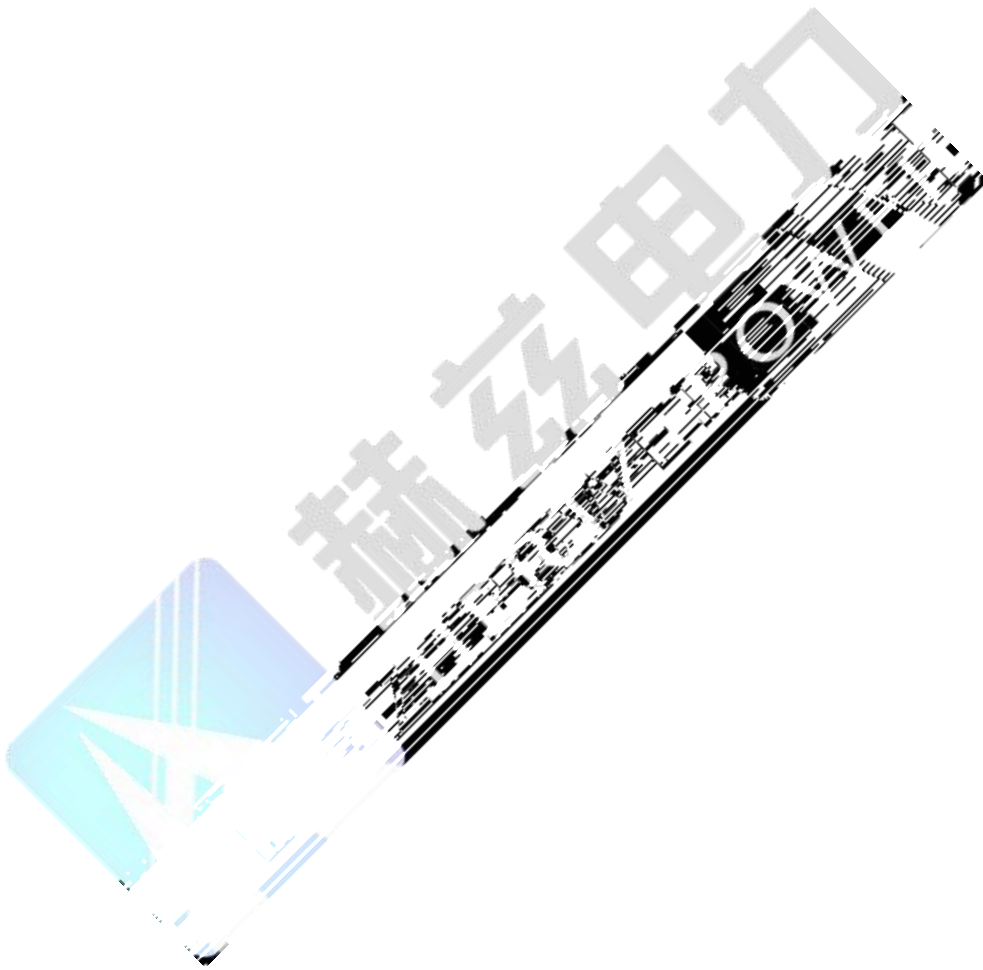

	uF/km									
	YJV	YJLV	YJV	YJLV	YJV	YJLV	YJV	YJLV	YJV	YJLV
	6/6KV		8.7/10KV		12/20KV		21/35KV		26/35KV	
	6/10KV		8.7/15KV							
1*35	0.212		0.173		0.152					
1*50	0.237		0.192		0.166		0.118		0.114	
1*70	0.270		0.217		0.187		0.131		0.125	
1*95	0.301		0.240		0.206		0.143		0.135	
1*120	0.327		0.261		0.223		0.153		0.143	
1*150	0.358		0.284		0.241		0.164			

